

REVISIONS

P	LTR	DESCRIPTION	DATE	DWN	APVD
A		NEW RELEASE PER ECO-14-013592	09-05-14	DM	DM



Backshell

Compression Nut

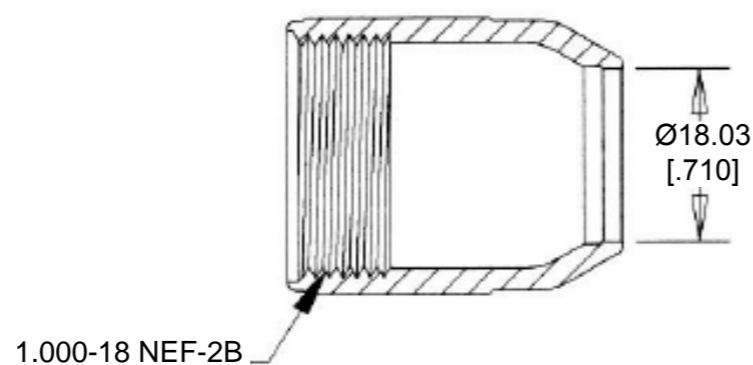
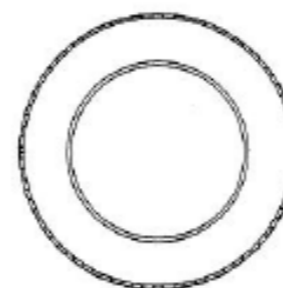
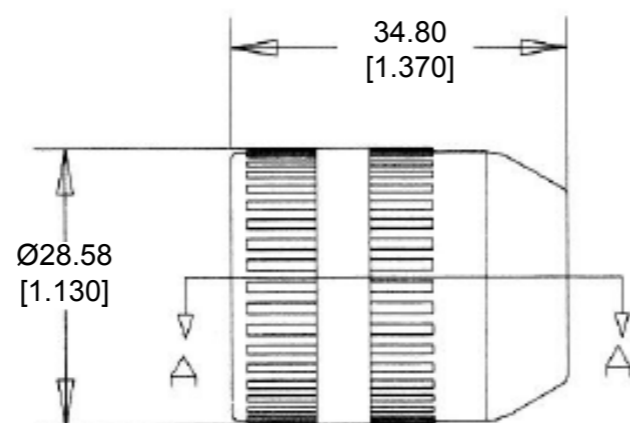

SECTION A-A

4. PART NO. M902-2054

3. CABLE SIZE: Ø.570 - Ø.710

2. TEMPERATURE RATING: -40°C TO +134°C [-40°F TO +273°F]

1. THIS PART IS USED WITH  
 BACKSHELL, M902-2164 (HD10, SIZE 6)  
 BACKSHELL, M902-2194 (HD10, SIZE 9)  
 BACKSHELL, M902-2244 (HDP20, SIZE 24 -L015 MOD)

THIS DRAWING IS A CONTROLLED DOCUMENT.		DWN D. MEYER 05SEP2014														
DIMENSIONS: MM [INCH]		CHK I. GRANTCHAROVA 05SEP2014														
TOLERANCES UNLESS OTHERWISE SPECIFIED:		APVD D. MEYER 05SEP2014	NAME NUT, COMPRESSION, SIZE 6,9,24 CABLE SIZE: Ø.570 - Ø.710 HD10/HDP20 SERIES													
<table border="0"> <tr><td>0 PLC</td><td>±</td></tr> <tr><td>1 PLC</td><td>±</td></tr> <tr><td>2 PLC</td><td>± .63 [.025]</td></tr> <tr><td>3 PLC</td><td>±</td></tr> <tr><td>4 PLC</td><td>±</td></tr> <tr><td>ANGLES</td><td>± 5°</td></tr> </table>		0 PLC	±	1 PLC	±	2 PLC	± .63 [.025]	3 PLC	±	4 PLC	±	ANGLES	± 5°	PRODUCT SPEC	SIZE A3	
0 PLC	±															
1 PLC	±															
2 PLC	± .63 [.025]															
3 PLC	±															
4 PLC	±															
ANGLES	± 5°															
MATERIAL PC/PBT		APPLICATION SPEC	CAGE CODE 4AFU8	DRAWING NO. M902-2054												
FINISH BLACK		WEIGHT 9.32 g	RESTRICTED TO -													
		Customer Drawing	SCALE NONE	SHEET 1 OF 1 REV A												